

621E Wheel Loader Repair Manual 87723028 A - EU

Table of Contents

Description	Section No.
General	Tab 1
Section Index - General	
Standard Torque Specifications	1001
Fluids and Lubricants	1002
Metric Conversion Chart	1003
Engines	Tab 2
Section Index - Engines	
Engine and Radiator Removal and Installation	2000
Stall Tests	2002
After Cooler	2003
For Engine Repair, See the Engine Service Manual 87519803	
Fuel System	Tab 3
Section Index - Fuel System	
For Fuel System Repair, See the Engine Service Manual 87519803	
Electrical	Tab 4
Section Index - Electrical	
Removal and Installation of Starter and Alternator	4001
Electrical Specifications and Troubleshooting	4002
Batteries	4003
Instrument Cluster	4005
Steering	Tab 5
Section Index - Steering	
Removal and Installation of Steering Components	5001
Steering Specifications, Pressure Checks, and Troubleshooting	5002
Steering Cylinders	5005
Center Pivot	5006
Auxiliary Steering Motor and Pump	5008

621E Wheel Loader Repair Manual 87723028 A - EU

Table of Contents

Description	Section No.
Power Train	
	Tab 6
Section Index - Power Train	
Removal and Installation of Power Train Components	6001
Transmission Specifications, Pressure Checks, and Troubleshooting	6002
Transmission	6003
Front Axle	6004
Rear Axle	6004
Drive Shafts, Center Bearing, and Universal Joints	6005
Wheels and Tires	6006
Transmission Control Valve	6007
Brakes	
	Tab 7
Section Index - Brakes	
Removal and Installation of Brake Components	7001
Hydraulic Brake Troubleshooting	7002
Brake Pump	7003
Brake Accumulators	7004
Parking Brake	7008
Hydraulics	
	Tab 8
Section Index - Hydraulics	
How to Read Hydraulic Schematics	8000
Removal and Installation of Hydraulic Components	8001
Hydraulic Specifications, Troubleshooting, and Pressure Checks	8002
Cleaning the Hydraulic System	8003
Hydraulic Pump	8004
Loader Control Valve	8005
Cylinders	8006
Coupler Solenoid Locking Valve	8007
Ride Control Accumulator	8013
Ride Control Valve	8014

621E Wheel Loader Repair Manual 87723028 A - EU

Table of Contents

Description	Section No.
Mounted Equipment	Tab 9
Section Index - Mounted Equipment	
Air Conditioning Troubleshooting and System Checks For Systems with HFC-134a Refrigerant	9002
Air Conditioner System Service	9003
Removal And Installation Of Air Conditioning And Heater Components	9004
Loader	9006
Roll Over Protective Structure (ROPS), Cab Structural Frame (CSF)	9007
Cab Glass Installation	9010
Electrical Schematic Foldouts and Hydraulic Schematic Foldout	In Rear Pocket

**Thanks very much for your reading,
Want to get more information,
Please click here, Then get the complete
manual**

JustClickHere 

NOTE:

**If there is no response to click on the link above,
please download the PDF document first, and then
click on it.**

**Have any questions please write to me:
admin@servicemanualperfect.com**

SECTION INDEX

GENERAL

Section Title	Section Number
Standard Torque Specifications	1001
Fluids and Lubricants	1002
Metric Conversion Chart	1003

Section 1001

GENERAL TORQUE SPECIFICATIONS

TABLE OF CONTENTS

TORQUE SPECIFICATIONS - DECIMAL HARDWARE	3
TORQUE SPECIFICATIONS - METRIC HARDWARE	4
TORQUE SPECIFICATIONS - STEEL HYDRAULIC FITTINGS	5
TORQUE SPECIFICATIONS - STEEL HYDRAULIC FITTINGS	6

TORQUE SPECIFICATIONS - DECIMAL HARDWARE

Use the torques in this chart when special torques are not given. These torques apply to fasteners with both UNC and UNF threads as received from suppliers dry, or when lubricated with engine oil. Not applicable if special graphities, Molydisulfide greases, or other extreme pressure lubricants are used.

Grade 5 Bolts, Nuts, and Studs		
		
Size	Pound-Inches	Newton metres
1/4 inch	108 to 132	12 to 15
5/16 inch	204 to 252	23 to 28
3/8 inch	420 to 504	48 to 57
Size	Pound-Feet	Newton metres
7/16 inch	54 to 64	73 to 87
1/2 inch	80 to 96	109 to 130
9/16 inch	110 to 132	149 to 179
5/8 inch	150 to 180	203 to 244
3/4 inch	270 to 324	366 to 439
7/8 inch	400 to 480	542 to 651
1.0 inch	580 to 696	787 to 944
1-1/8 inch	800 to 880	1085 to 1193
1-1/4 inch	1120 to 1240	1519 to 1681
1-3/8 inch	1460 to 1680	1980 to 2278
1-1/2 inch	1940 to 2200	2631 to 2983

Grade 8 Bolts, Nuts, and Studs		
		
Size	Pound-Inches	Newton metres
1/4 inch	144 to 180	16 to 20
5/16 inch	288 to 348	33 to 39
3/8 inch	540 to 648	61 to 73
Size	Pound-Feet	Newton metres
7/16 inch	70 to 84	95 to 114
1/2 inch	110 to 132	149 to 179
9/16 inch	160 to 192	217 to 260
5/8 inch	220 to 264	298 to 358
3/4 inch	380 to 456	515 to 618
7/8 inch	600 to 720	814 to 976
1.0 inch	900 to 1080	1220 to 1465
1-1/8 inch	1280 to 1440	1736 to 1953
1-1/4 inch	1820 to 2000	2468 to 2712
1-3/8 inch	2380 to 2720	3227 to 3688
1-1/2 inch	3160 to 3560	4285 to 4827

NOTE: Use thick nuts with Grade 8 bolts.

TORQUE SPECIFICATIONS - METRIC HARDWARE

Use the following torques when specifications are not given.

These values apply to fasteners with coarse threads as received from supplier, plated or unplated, or when lubricated with engine oil. These values do not apply if graphite or Molydisulfide grease or oil is used.

Grade 8.8 Bolts, Nuts, and Studs		
		
Size	Pound-Inches	Newton metres
M4	24 to 36	3 to 4
M5	60 to 72	7 to 8
M6	96 to 108	11 to 12
M8	228 to 276	26 to 31
M10	456 to 540	52 to 61
Size	Pound-Foot	Newton metres
M12	66 to 79	90 to 107
M14	106 to 127	144 to 172
M16	160 to 200	217 to 271
M20	320 to 380	434 to 515
M24	500 to 600	675 to 815
M30	920 to 1100	1250 to 1500
M36	1600 to 1950	2175 to 2600

Grade 10.9 Bolts, Nuts, and Studs		
		
Size	Pound-Inches	Newton metres
M4	36 to 48	4 to 5
M5	84 to 96	9 to 11
M6	132 to 156	15 to 18
M8	324 to 384	37 to 43
Size	Pound-Foot	Newton metres
M10	54 to 64	73 to 87
M12	93 to 112	125 to 150
M14	149 to 179	200 to 245
M16	230 to 280	310 to 380
M20	450 to 540	610 to 730
M24	780 to 940	1050 to 1275
M30	1470 to 1770	2000 to 2400
M36	2580 to 3090	3500 to 4200

Grade 12.9 Bolts, Nuts, and Studs

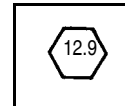

Usually the torque values specified for grade 10.9 fasteners can be used satisfactorily on grade 12.9 fasteners.

TORQUE SPECIFICATIONS - STEEL HYDRAULIC FITTINGS

37 Degree Flare Fitting			
Tube OD Hose ID	Thread Size	Pound- Inches	Newton metres
1/4 inch 6.4 mm	7/16-20	72 to 144	8 to 16
5/16 inch 7.9 mm	1/2-20	96 to 192	11 to 22
3/8 inch 9.5 mm	9/16-18	120 to 300	14 to 34
1/2 inch 12.7 mm	3/4-16	180 to 504	20 to 57
5/8 inch 15.9 mm	7/8-14	300 to 696	34 to 79
Tube OD Hose ID	Thread Size	Pound- Feet	Newton metres
3/4 inch 19.0 mm	1-1/16-12	40 to 80	54 to 108
7/8 inch 22.2 mm	1-3/16-12	60 to 100	81 to 135
1.0 inch 25.4 mm	1-5/16-12	75 to 117	102 to 158
1-1/4 inch 31.8 mm	1-5/8-12	125 to 165	169 to 223
1-1/2 inch 38.1 mm	1-7/8-12	210 to 250	285 to 338

Straight Threads with O-ring			
Tube OD Hose ID	Thread Size	Pound- Inches	Newton metres
1/4 inch 6.4 mm	7/16-20	144 to 228	16 to 26
5/16 inch 7.9 mm	1/2-20	192 to 300	22 to 34
3/8 inch 9.5 mm	9/16-18	300 to 480	34 to 54
1/2 inch 12.7 mm	3/4-16	540 to 804	57 to 91
Tube OD Hose ID	Thread Size	Pound- Feet	Newton metres
5/8 inch 15.9 mm	7/8-14	58 to 92	79 to 124
3/4 inch 19.0 mm	1-1/16-12	80 to 128	108 to 174
7/8 inch 22.2 mm	1-3/16-12	100 to 160	136 to 216
1.0 inch 25.4 mm	1-5/16-12	117 to 187	159 to 253
1-1/4 inch 31.8 mm	1-5/8-12	165 to 264	224 to 357
1-1/2 inch 38.1 mm	1-7/8-12	250 to 400	339 to 542

Split Flange Mounting Bolts		
Size	Pound- Inches	Newton metres
5/16-18	180 to 240	20 to 27
3/8-16	240 to 300	27 to 34
7/16-14	420 to 540	47 to 61
Size	Pound- Feet	Newton metres
1/2-13	55 to 65	74 to 88
5/8-11	140 to 150	190 to 203

TORQUE SPECIFICATIONS - STEEL HYDRAULIC FITTINGS

O-ring Face Seal End					O-ring Boss End Fitting or Lock Nut		
Nom. SAE Dash Size	Tube OD	Thread Size	Pound-Inches	Newton metres	Thread Size	Pound-Inches	Newton metres
-4	1/4 inch 6.4 mm	9/16-18	120 to 144	14 to 16	7/16-20	204 to 240	23 to 27
-6	3/8 inch 9.5 mm	11/16-16	216 to 240	24 to 27	9/16-18	300 to 360	34 to 41
-8	1/2 inch 12.7 mm	13/16-16	384 to 480	43 to 54	3/4-16	540 to 600	61 to 68
					Thread Size	Pound-Feet	Newton metres
-10	5/8 inch 15.9 mm	1-14	552 to 672	62 to 76	7/8-14	60 to 65	81 to 88
Nom. SAE Dash Size	Tube OD	Thread Size	Pound-Feet	Newton metres	1-1/16-12	85 to 90	115 to 122
					1-3/16-12	95 to 100	129 to 136
-12	3/4 inch 19.0 mm	1-3/16-12	65 to 80	90 to 110	1-5/16-12	115 to 125	156 to 169
-14	7/8 inch 22.2 mm	1-3/16-12	65 to 80	90 to 110	1-5/8-12	150 to 160	203 to 217
-16	1.0 inch 25.4 mm	1-7/16-12	92 to 105	125 to 140	1-7/8-12	190 to 200	258 to 271
-20	1-1/4 inch 31.8 mm	1-11/16-12	125 to 140	170 to 190			
-24	1-1/2 inch 38.1 mm	2-12	150 to 180	200 to 254			

Section 1002

1002

FLUIDS AND LUBRICANTS

TABLE OF CONTENTS

CAPACITIES AND LUBRICANTS	3
ENGINE OIL RECOMMENDATIONS	4
TRANSMISSION TEMPERATUER CHART	5
DIESEL FUEL SYSTEM	5
Fuel Storage	5
Specifications for Acceptable No. 2 Diesel Fuel	5
MAINTENANCE SCHEDULE	6
Model 621E	6
MAINTENANCE POINTS	7
Model 621E	7

CAPACITIES AND LUBRICANTS

Engine Oil

Capacity with Filter Change 13.2 liters (14 U.S. Quarts)
 Type of oil..... See engine oil recommendations on page 4

Engine Cooling System

Capacity 36.0 liters (38 U.S. Quarts)
 Type of Coolant.....50% water and 50% Ethylene Glycol

Fuel Tank

Capacity 246 liters (65 U.S. Gallons)
 Type of Fuel See Diesel fuel specifications on page 5

Hydraulic System

Hydraulic Reservoir Refill Capacity90.8 liters (24.0 U.S. Gallons)
 Total System Capacity147.6 liters (39.0 U.S. Gallons)
 Type of Oil Case AKCELA Hy-Tran Ultra®

Transmission

Refill Capacity with Filter Change 19.9 liters (21 U.S. Quarts)
 Total System Capacity 26.7 liters (28.2 U.S. Quarts)
 Type of Oil Case AKCELA No. 1 15W-40

Axles

Capacity
 Front..... 22.0 liters (23.2 U.S. Quarts)
 Rear 22.0 liters (23.2 U.S. Quarts)
 Type of Lubricant Case AKCELA Transaxle Fluid

NOTE: *DO NOT use an alternate oil in the axles. The brake components in the axles could be damaged as a result of using an alternate oil. Machines are shipped from the factory with break-in oil.*

Brake System

Type of Fluid (Same as Hydraulic System) Case AKCELA Hy-Tran Ultra®

ENGINE OIL RECOMMENDATIONS

Case AKCELA No. 1 Engine oil is recommended for use in your Case engine. Case AKCELA No. 1 Engine Oil will lubricate your engine correctly under all operating conditions.

If Case AKCELA No. 1 Multi-Viscosity Oil is not available, use only oil meeting API engine oil service category CH-4 (preferred) or CG-4.



BD03A102



See the chart below for recommended viscosity at ambient air temperature ranges.

NOTE: Do not put performance additives or other oil additive products in the engine crankcase. The oil change intervals given in this manual are according to tests with Case AKCELA lubricants.

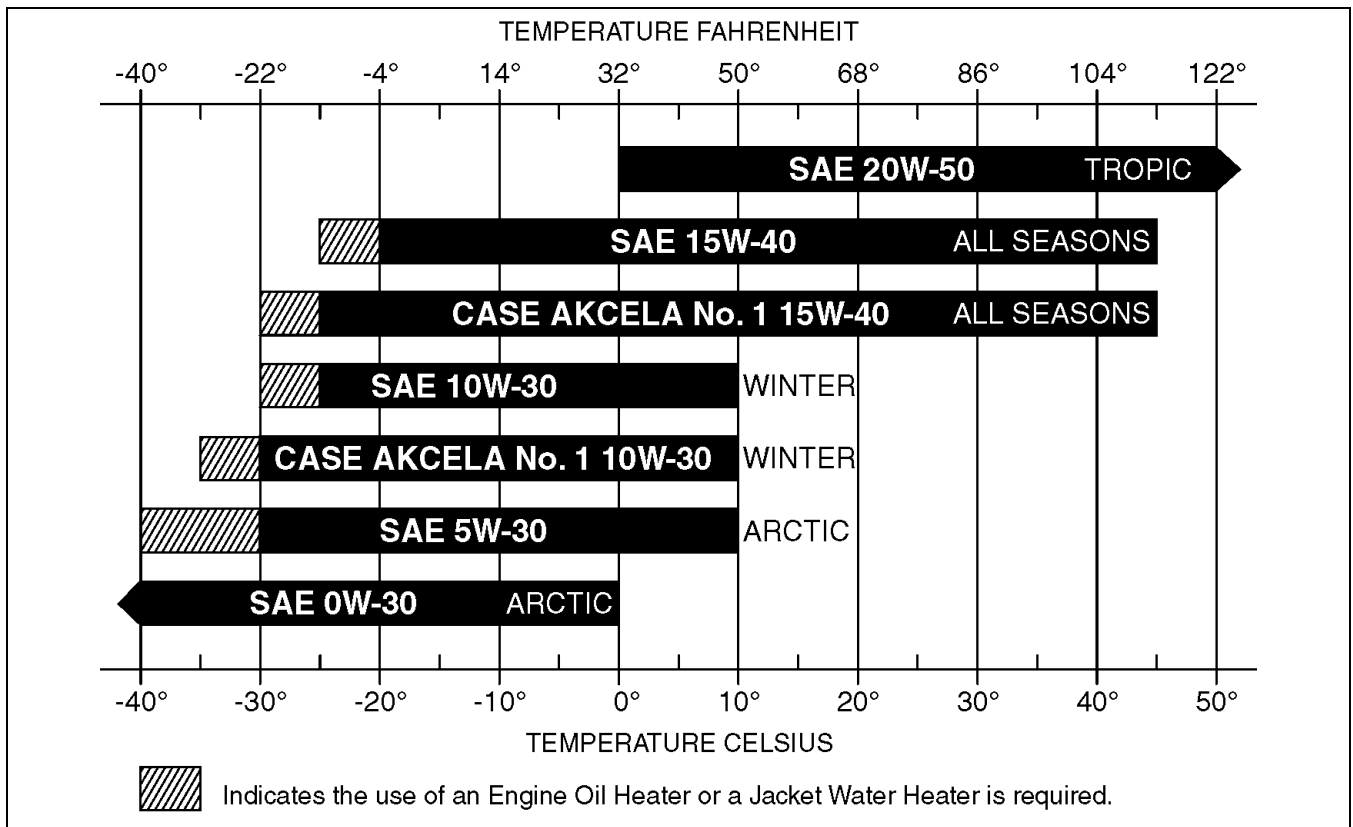

BC02N250

TRANSMISSION TEMPERATUER CHART

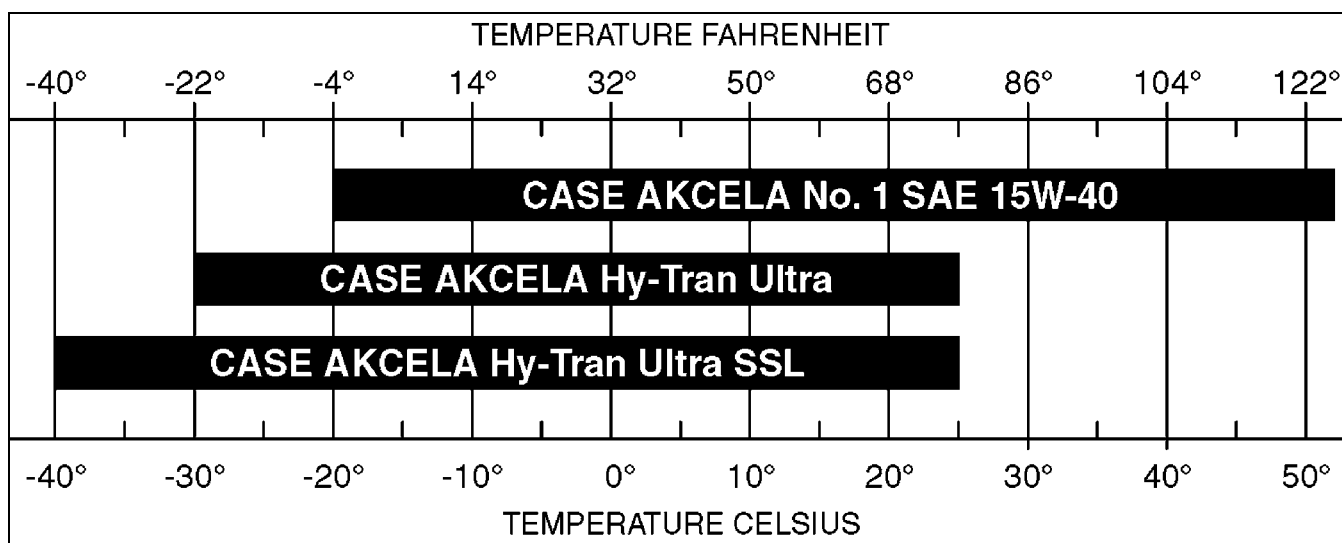

BC04F193

DIESEL FUEL SYSTEM

Use No. 2 diesel fuel in the engine of this machine. The use of other fuels can cause the loss of engine power and high fuel consumption.

In very cold temperatures, a mixture of No. 1 and No. 2 diesel fuels is temporarily permitted. See the following Note.

NOTE: See your fuel dealer for winter fuel requirements in your area. If the temperature of the fuel lowers below the cloud point (wax appearance point), wax crystals in the fuel will restrict the fuel filter and cause the engine to lose power or not start.

The diesel fuel used in this machine must meet the specifications as shown below in, "Specifications for Acceptable No. 2 Diesel Fuel", or "Specification D975-81" of the American Society for Testing and Materials.

Specifications for Acceptable No. 2 Diesel Fuel

API gravity, minimum	34
Flash point, minimum	60°C (140°F)
Cloud point (wax appearance point), maximum	-20°C (-5°F) See Note above
Pour point, maximum	-26°C (-15°F) See Note above
Distillation temperature, 90% point	282 to 338°C (540 to 640°F)
Viscosity, at 38°C (100°F)	
Centistokes	2.0 to 4.3
Cetane number, minimum	43 (45 to 55 for winter or high altitudes)
Water and sediment, by volume, maximum	0.05%

Fuel Storage

If you keep fuel in storage for a period of time, you can get foreign material or water in the fuel storage tank. Many engine problems are caused by water in the fuel.

Keep the fuel storage tank outside and keep the fuel as cool as possible. Remove water from the storage container at regular periods of time.

Fill the fuel tank at the end of the daily operating period to prevent condensation in the fuel tank.

MAINTENANCE SCHEDULE

Model 621E

SERVICE INTERVAL	ITEM NUMBER	SERVICE POINTS	Initial Service	FREQUENCY IN HOURS							
				CHECK	CLEAN	CHANGE	DRAIN	LUBRICATE	REPLACE	ADJUST	
Variable Periodic (*)	29	Air cleaner		*	*						
	18	Bleed Fuel Filter of Condensation					*				
	19	Hydraulic Filter		*							
	22	Alternator, AC, Drive Belt		*							
	13	Radiator Coolant Level		*							
	XX	Fire extinguisher		*							
	14	Tires		*							
Every 10 Hours	1	Check Engine Oil Level		10							
Every 50 Hours	2	Check Engine Coolant Level		50							
	3	Check Transmission Oil Level		50							
	4	Check Hydraulic Oil Level		50							
	5 & 6	Grease Bucket Mounting Fittings						50			
Every 100 Hours	7	Grease Front Drive Shaft Support Bearing						100			
	8 & 9	Lubricate The Steering Cylinder Pivots - Rod And Closed End (4 Fittings)						100			
	10	Lubricate Loader Lift & Cylinder Pivots (10) Z-bar						100			
	11	Lubricate Loader Lift & Cylinder Pivots (18) XT						100			
Every 250 Hours	12	Check Cab Air Filter		250							
	13	Check Tire Pressure & Wheel Torque	100	250							
	14	Check Drive Belt		250							
Every 500 Hours	15	Check Battery Electrolyte Level		500							
	16	Check Axle Oil Level		500							
	17	Drain Fuel Tank Condensation & Water Separator					500				
	18	Change Engine Oil and Filter	100			500					
	18	Change Crankcase Filter				500					
	19 & 27	Replace Fuel Filter	100						500		
	XX	ROPS/CSF and seat belt torques		500							
Every 1000 Hours	20	Change Front & Rear Axle Oil	100			1000					
	21	Replace Hydraulic Oil filter	100						1000		
	22	Replace Cab Air Filter							1000		
	23	Replace Drive Belt							1000		
	24	Change Transmission Oil and Filter	100			1000					
	25	Grease Articulation Fittings						1000			
	26	Check Injector Calibration		1000							
	27	Fuel Pre-Filter				1000					
	XX	Drive Shaft Slip Joint						1000			
	XX	Check Valve Adjustment (Engine Manual)		1000							
	XX	Trans Clutch Calibration (See Section 6002)	250	1000							
Every 2000 Hours	28	Change Hydraulic Oil				2000					
	29	Change Coolant				2000					
	30	Replace Engine Air Cleaner							2000		
Every 4000 Hours	XX	Valve Clearance (Engine Manual)								4000	

MAINTENANCE POINTS

Model 621E

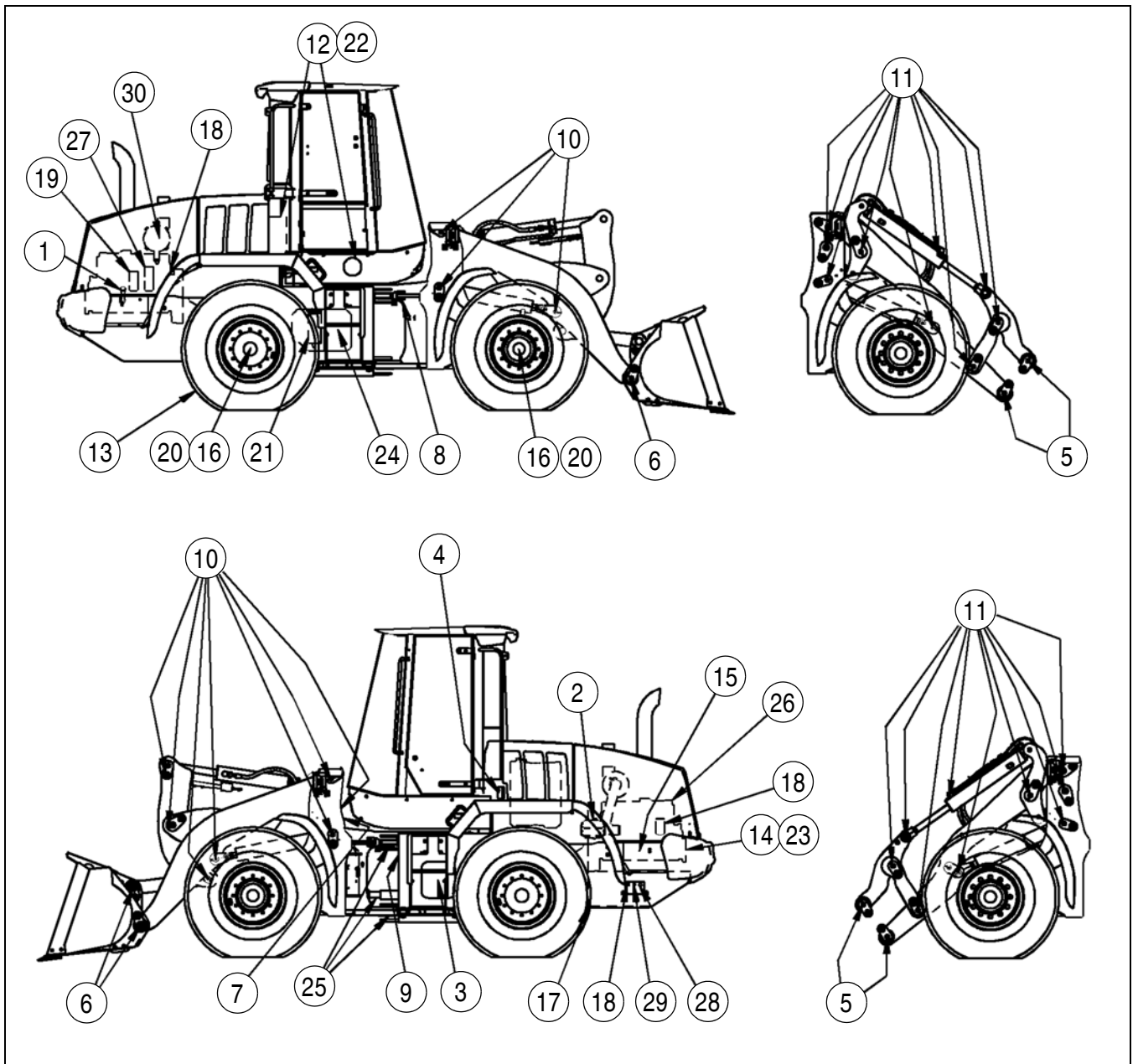

BS07D423

See your Operators manual for maintenance of safety related items and for detailed information of the service items on this chart. Operators and service manuals are available for this machine from your dealer.

If you operate the machine in severe conditions, lubricate and service the machine more frequently.

NOTES

Section 1003

1003

METRIC CONVERSION CHART